

ECO

Caractéristiques Techniques

- Tête céramique de ½".
- Débit à 3 bar : lavabo, bidet et évier (de 9 à 12 l/min). Douche (de 12 à 16 l/min). Bain-douche (≥20 l/min).
- Niveau acoustique à 3 bar < 20 dB.
- Chromé laiton : épaisseur du nickel :15 microns, épaisseur du chrome : 0,3 microns.
- Pression d'utilisation 1-5 bar, recommandée à 3 bar. Résiste aux pressions statiques ≤ 10 bar et coup de bélier de 25 bar.
- Température d'eau recommandée: 55°C. Température maximale d'utilisation: 65°C. Maximum 1 h à 90°C.
- Résistant aux chocs thermiques et agents chimiques antilégionelles.
- Garantie 5 ans (robinetterie) et 3 ans (accessoires).



CH



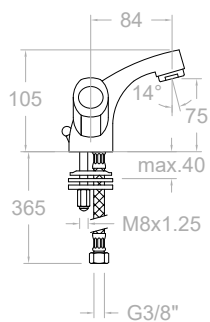

**700112E6**

70A306297

Mélangeur lavabo. Têtes à clapet.
Croisillons laiton.**700112VA9065E6**

70A306299

Mélangeur lavabo. Têtes à clapet.
Croisillons laiton. Avec vidage ABS.**700112VA1167E6**

70A306298

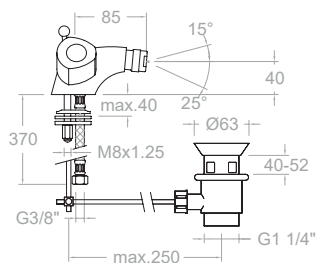
Mélangeur lavabo. Têtes à clapet.
Croisillons laiton. Avec vidage laiton.**7003E4**

803232

Mélangeur bidet. Têtes à clapet.
Croisillons laiton.**7003VA9065E4**

158527

Mélangeur bidet. Têtes à clapet.
Croisillons laiton. Avec vidage ABS.**7003VA1167E4**

162087

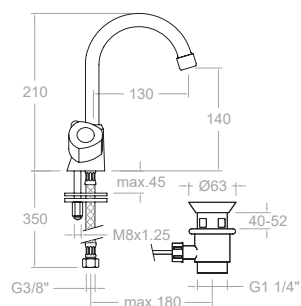
Mélangeur bidet. Têtes à clapet.
Croisillons laiton. Avec vidage laiton.**7010CE10E4**

803189

Mélangeur lavabo bec tube
orientable. Têtes à clapet. Croisillons
laiton.**7010CE10VA9065E4**

158475

Mélangeur lavabo bec tube orientable.
Têtes à clapet. Croisillons laiton. Avec
vidage ABS.**7010CE10VA1167E4**

162078

Mélangeur lavabo bec tube orientable.
Têtes à clapet. Croisillons laiton. Avec
vidage laiton.

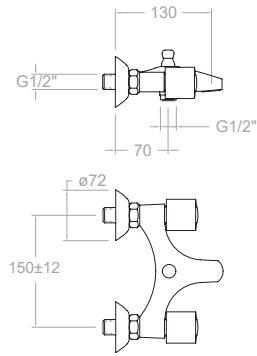

7006SE4

161160

Mélangeur bain-douche. Têtes à clapet. Croisillons laiton.



7006VM2E4

70C306234

7006SE4+351502+3544+1128C

Mélangeur bain-douche avec ensemble douche.



Tête: 5000

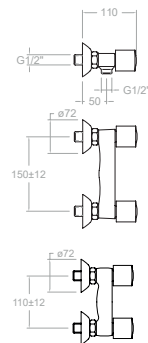

7004SE4

156752

Mélangeur douche sans ensemble de douche (150 mm).



7014SE4

191526

Mélangeur douche sans ensemble de douche (110 mm). Têtes à clapet. Croisillons laiton.



7004VM2E4

70D306235

7004SE4+351502+3544+1128C

Mélangeur douche. Têtes à clapet. Croisillons laiton. Avec ensemble de douche VM. Douchette 1 jet.

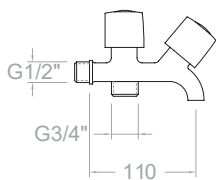

Tête: 5000

**5079E4A**

153951

Robinet double pour machine à laver, sortie 3/4". Tête à clapet. Croisillon laiton. Saillie 110 mm.

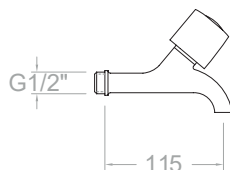

Tête: 5000

**5070/12E4A**

803768

Robinet d'office. Tête à clapet. Croisillon laiton. Saillie 115 mm.

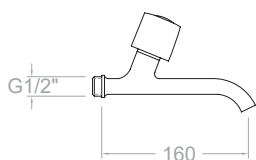

Tête: 5000

**5070/17E4A**

803820

Robinet d'office. Tête à clapet. Croisillon laiton. Saillie 160 mm.

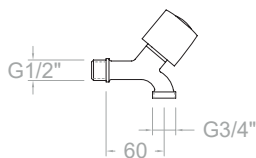

Tête: 5000

**5069E4A**

803321

Robinet simple pour machine à laver. Tête à clapet. Croisillon laiton. Saillie 60 mm.

**5069E4R**

70F303235

Robinet simple pour machine à laver. Tête à clapet. Croisillon laiton. Saillie 60 mm.

Tête: 5000

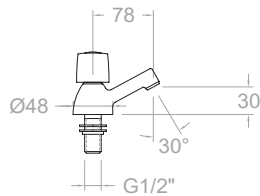

7012X1E4A
253545

Robinet simple Lavabo 1/2". Tête à clapet. Croisillon laiton.
Hauteur sous bec 30 mm, saillie 78 mm.



7012X1E4R
253554

Robinet simple Lavabo 1/2". Tête à clapet. Croisillon laiton.
Hauteur sous bec 30 mm, saillie 78 mm.

Tête: 5000

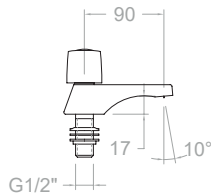

7002X1E4A
253491

Robinet simple Lavabo 1/2". Tête à clapet. Croisillon laiton.
Hauteur sous bec 17 mm, saillie 90 mm.



7002X1E4R
253500

Robinet simple Lavabo 1/2". Tête à clapet. Croisillon laiton.
Hauteur sous bec 17 mm, saillie 90 mm.

Tête: 5000

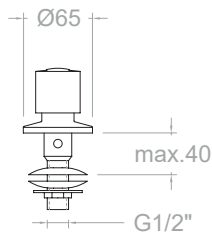

7005X1E4A
253509

Robinet simple Bidet 1/2". Tête à clapet. Croisillon laiton Eau froide.



7005X1E4R
253518

Robinet simple Bidet 1/2". Tête à clapet. Croisillon laiton. Eau chaude.

Tête: 5000

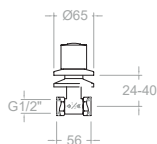

● **70073/4X1E4R**
253383

Robinet d'arrêt. Tête à clapet.
Croisillon laiton. Eau chaude.

● **70073/4X1E4A**
253374

Robinet d'arrêt. Tête à clapet.
Croisillon laiton. Eau froide.

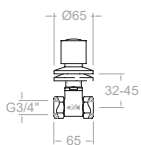

● **70071/2X1E4R**
253482

Robinet d'arrêt. Tête à clapet.
Croisillon laiton. Eau chaude.

● **70071/2X1E4A**
253473

Robinet d'arrêt. Tête à clapet.
Croisillon laiton. Eau froide.

Tête: 5000

Tête: 6000

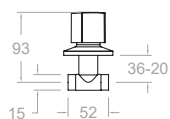

● **7007T15X1E4R**
253401

Robinet d'arrêt à souder. Tête à
clapet. Croisillon laiton. Eau chaude.

● **7007T15X1E4A**
253392

Robinet d'arrêt à souder. Tête à
clapet. Croisillon laiton. Eau froide.

Tête: 5000

Tête: 5000

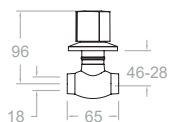

● **7007T18X1E4R**
253446

Robinet d'arrêt à souder. Tête à
clapet. Croisillon laiton. Eau chaude.

● **7007T18X1E4A**
253410

Robinet d'arrêt à souder. Tête à
clapet. Croisillon laiton. Eau froide.

Tête: 6000

Tête: 6000

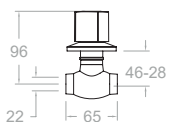

● **7007T22X1E4R**
253464

Robinet d'arrêt à souder. Tête à
clapet. Croisillon laiton. Eau chaude.

● **7007T22X1E4A**
253455

Robinet d'arrêt à souder. Tête à
clapet. Croisillon laiton. Eau froide.

Tête: 6000

Tête: 6000

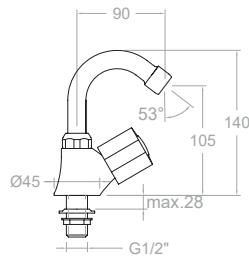

7028X1CE11E4R

261303

Robinet avec bec tube orientable (CE11). Eau chaude



7028X1CE11E4A

261614

Robinet avec bec orientable (CE 11) Eau froide.

Tête: 5000

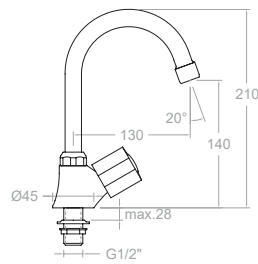

7028X1CE10E4R

261294

Robinet avec bec tube orientable (CE10). Eau chaude



7028X1CE10E4A

261613

Robinet avec bec tube orientable (CE10) Eau froide.

Tête: 5000

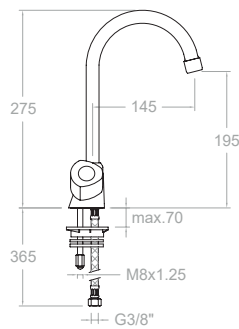

7008CE08YE4

803278

Mélangeur évier bec tube orientable. Tête à clapet. Croisillons laiton.



Tête: 5000

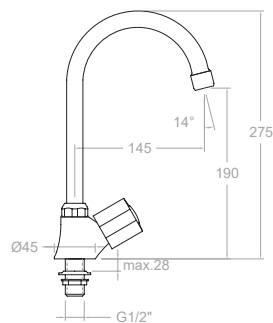

7028X1CE08YE4A

261611

Robinet avec bec orientable. Tête à clapet. Croisillon laiton. Eau froide.



7028X1CE08YE4R

261276

Robinet avec bec orientable. Tête à clapet. Croisillon laiton. Eau chaude

Tête: 5000

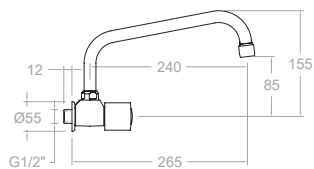
**7029X1CAI30E4A**

261715

Robinet mural avec bec orientable. Raccord 1/2". Tête à clapet. Croisillon laiton. Saillie 240 mm. Eau froide.

**7029X1CAI30E4R**

261366

Robinet mural avec bec orientable. Raccord 1/2". Tête à clapet. Croisillon laiton. Saillie 240 mm. Eau chaude.

Tête: 5000

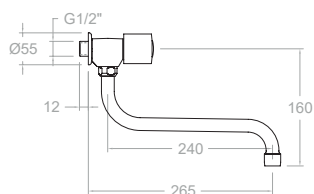
**7029X1CB30E4A**

261717

Robinet mural avec bec orientable. Raccord 1/2". Tête à clapet. Croisillon laiton. Saillie 240 mm. Eau froide.

**7029X1CB30E4R**

261384

Robinet mural avec bec orientable. Raccord 1/2". Tête à clapet. Croisillon laiton. Saillie 240 mm. Eau chaude.

Tête: 5000

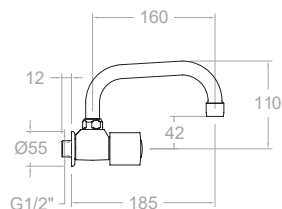
**7029X1CA21E4A**

261711

Robinet mural avec bec orientable. Raccord 1/2". Tête à clapet. Croisillon laiton. Saillie 160 mm. Eau froide.

**7029X1CA21E4R**

261330

Robinet mural avec bec orientable. Raccord 1/2". Tête à clapet. Croisillon laiton. Saillie 160 mm. Eau chaude.

Tête: 5000

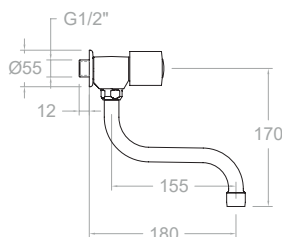
**7029X1CB21E4A**

261713

Robinet mural avec bec orientable. Raccord 1/2". Tête à clapet. Croisillon laiton. Saillie 155 mm. Eau froide.

**7029X1CB21E4R**

261348

Robinet mural avec bec orientable. Raccord 1/2". Tête à clapet. Croisillon laiton. Saillie 155 mm. Eau chaude.

Tête: 5000

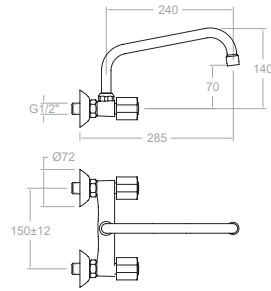

7009CAI30E4

803287

Mélangeur évier mural. Entraxe 150 mm +/- 24 mm. Tête à clapet. Croisillons laiton. Saillie 240 mm



Tête: 5000

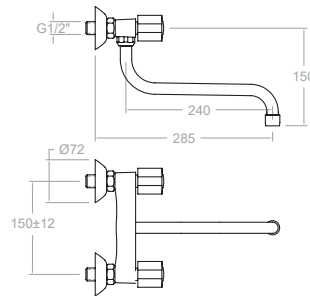

7009CB30E4

803296

Mélangeur évier mural. Entraxe 150 mm +/- 24 mm. Tête à clapet. Croisillons laiton. Saillie 240 mm



Tête: 5000

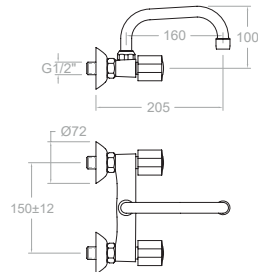

7009CA21E4

803893

Mélangeur évier mural. Entraxe 150 mm +/- 24 mm. Tête à clapet. Croisillons laiton. Saillie 160 mm



Tête: 5000

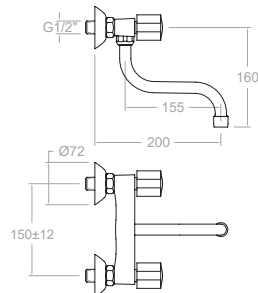

7009CB21E4

155441

Mélangeur évier mural. Entraxe 150 mm +/- 24 mm. Tête à clapet. Croisillons laiton. Saillie 115 mm



Tête: 5000

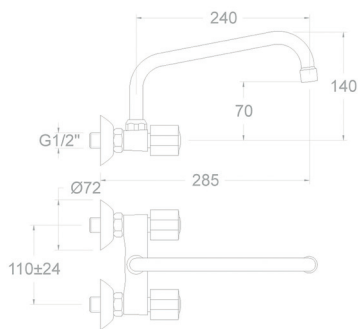

7005X1E4A

803303

Mélangeur évier mural. Entraxe 110 mm +/- 24 mm. Tête à clapet. Croisillons laiton. Saillie 240 mm



Tête: 5000

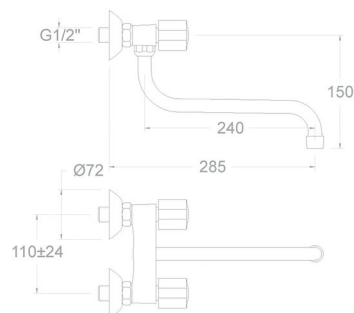

7019CB30E4

803312

Mélangeur évier mural. Entraxe 110 mm +/- 24 mm. Tête à clapet. Croisillons laiton. Saillie 240 mm



Tête: 5000

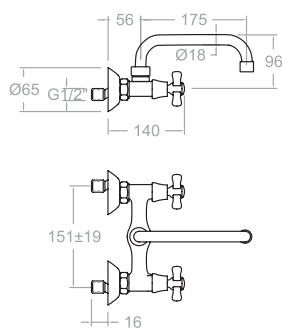

7019CA21E4

803964

Mélangeur évier mural. Entraxe 110 mm +/- 24 mm. Tête à clapet. Croisillons laiton. Saillie 160 mm



Tête: 5000

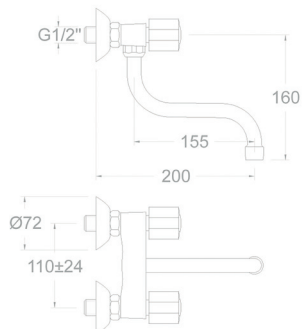

7019CB21E4

155502

Mélangeur évier mural. Entraxe 150 mm +/- 24 mm. Tête à clapet. Croisillons laiton. Saillie 155 mm



Tête: 5000