

Blautherm

Caractéristiques Techniques

- Cartouche céramique Ø35 mm.
- Cartouche thermostatique avec un système de sécurité Hot Block anti-brûlure et d'un Système Thermostop pour bloquer la température à 38 °C.
- Inverseur 2 voies.
- Système d'économie d'eau S2 avec ouverture en deux phases.
- Débit à 3 bar : Sortie bain 20 l/min, 12 l/min sortie douchette et 16 l/min sortie douche de tête.
- Résiste aux chocs thermiques et chimiques anti légionelles.
- Pression d'utilisation entre 1-5 bar. Recommandé 3 bar.
- Installation minimale recommandée avec des chauffe-eaux gaz ou électriques à partir de 10 litres et puissance de 18 Kw.
- Résiste à des pressions statiques égales ou inférieures à 10 bars et à des coups de bélier de 25 bars.
- Niveau acoustique à 3 bar : moins de 20 dB.
- Performance de confort en termes de fidélité, de sensibilité et de constance dans le choix de la température.
- Température recommandée de l'eau chaude 55°C.
Température maximale d'utilisation 65°C. Maximum 1h à 90°C.
- Surface chromée : 15 microns d'épaisseur de nickel, 0,3 microns de chrome.

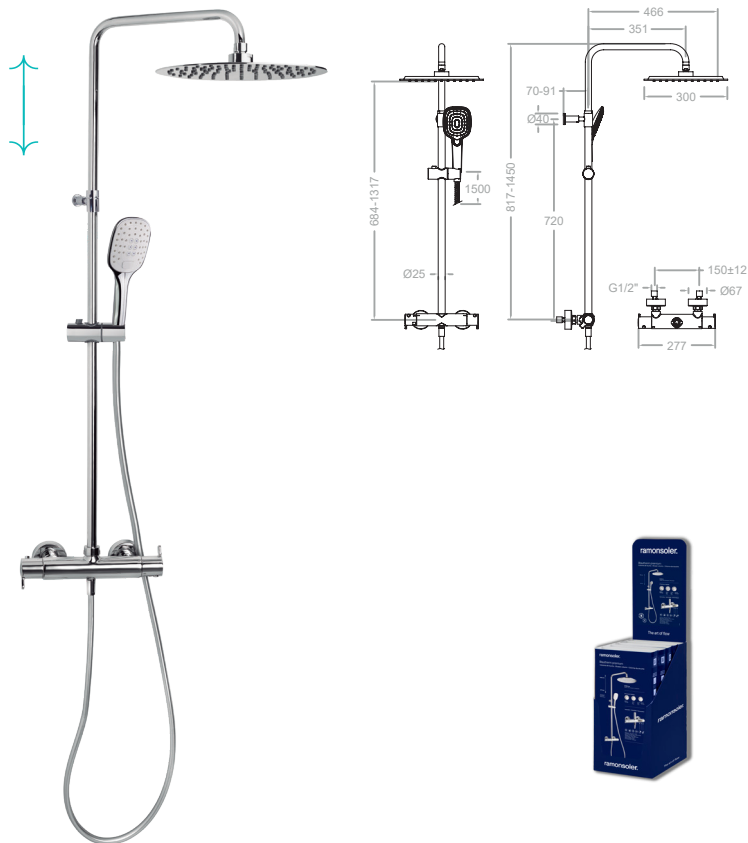



945404Q3RM300

94D308083

Colonne de douche thermostatique. Tube télescopique. Douche de tête en inox avec picots anticalcaires Ø300mm.

BX945404Q3RM300

94G308084

BOX PALET 5 Unités.



Cartouche: 1703T + 4000

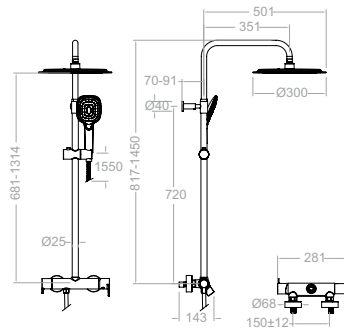

937415RP300

94D308931
932805S+DN132D+RP300+4914Q3+1128C

937415RP300NM

94D308927
932805SNM+DN132DNM+RP300NM+4914Q3NM+2475CNM

937415RP300OC

94D308928
932805SOC+DN132DOC+RP300OC+4914Q3OC+2475COC

Colonne mitigeur douche. Tube télescopique. Douche anticalcaire Ø 300 mm.

N



N



N



BX937415RP300

94G308855

BX937415RP300NM

94G308933

BX937415RP300OC

94G308934

BOX PALET 5 Unités.



Cartouche: 35100-2 (6689-2)+ 4004

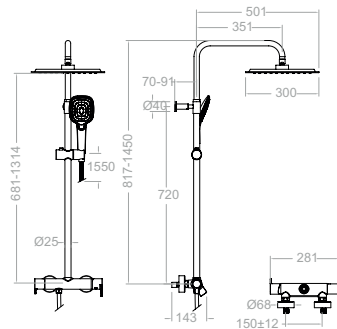

937415RPK300

94D308884
932805S+DN132D+RPK300+4914Q3+1128C

937415RPK300NM

94D308929
932805SNM+DN132DNM+RPK300NM+4914Q3NM+2475CNM

937415RPK300OC

94D308930
932805SOC+DN132DOC+RPK300OC+4914Q3OC+2475COC

Colonne mitigeur douche. Tube télescopique. Douche anticalcaire 300x300 mm.

N



N



N



BX937415RPK300

94G308856

BX937415RPK300NM

94G308935

BX937415RPK300OC

94G308936

Colonne mitigeur douche. Tube télescopique. Douche anticalcaire 300x300 mm.



Cartouche: 35100 (6689-2)+ 4004

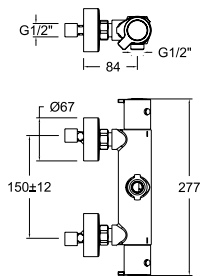

941202S
94D302999

941202SNM
94D303395

941202SOC
94D308061

Corp thermostatique pour colonne de douche.

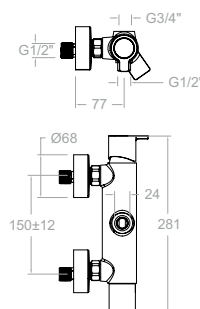
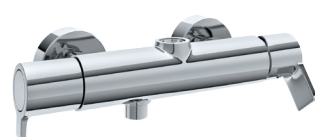

932805S
94D308734

932805SNM
94D308837

932805SOC
94D308836

Corp mitigeur pour colonne de douche.

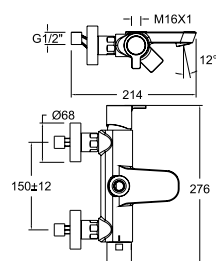

9346S
94C301682

9346SNM
94C304983

Corp mitigeur pour colonne de bain-douche.

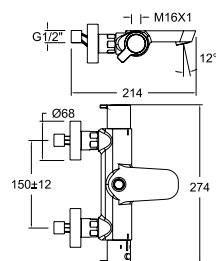
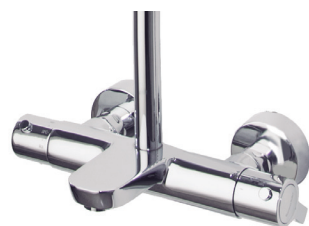

9446S
94C301683

9446SNM
94C304984

Corp thermostatique pour colonne de bain-douche.



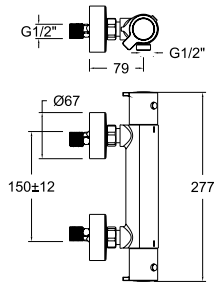

943402S
94D302071

943402SNM
94D308163

Mitigeur thermostatique douche. Poignées laiton. Blocage T°38°C

Cartouche: 1701T + 1700C1/2"



943403S
94D304490



Mitigeur thermostatique douche. Poignées laiton. Blocage T°38°C

CX943404SX6
94G305529

6 unités thermostatique Blautherm.



943402BT
94D303257

943402S+2876BT+3726+1128C

943404BTNM
94D307783

Thermostatique de douche avec ensemble de douche BT. Douchette 3 jets.



CX943402BTX6
94G303258

(943402S+2876BT+3726+1128C)x6

6 unités thermostatique Blautherm.



943402T1
94D302568

943402S+3520T1+3726+2471C

Mitigeur thermostatique douche avec ensemble de douche T1. Douchette 1 jet.



943402T3
94D302569

943402S+5840T3+3726+2471C

Mitigeur thermostatique douche avec ensemble de douche T3. Douchette 3 jets.



Tête: 1701C1/2 + 1702C1/2

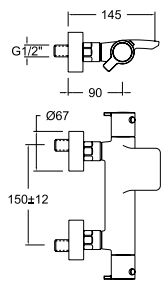
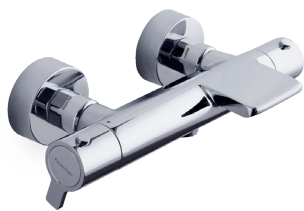

943901S

261649

Mitigeur thermostatique bain-douche. Bec Cascade. Poignées laiton. Inverseur à la poignée. Blocage T° 38°C. Entraxe 150 mm +/- 24 mm



943901T1

261652

943901S+3520T1+3726+2471C

Mitigeur thermostatique bain-douche. Bec Cascade. Poignées laiton. Inverseur à la poignée, avec ensemble T1. Douchette 1 jet.



943901T3

94C301946

943901S+5840T3+3726+2471C

Mitigeur thermostatique bain-Douche Bec cascade. Poignées laiton. Blocage T 38C. Avec ensemble T3. Douchette 3 jets.



Cartouche: 1701 T + 4001

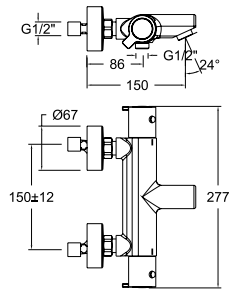

943801S

94C302075

943801SNM

94C307784

Mitigeur thermostatique bain-Douche Poignées laiton. Blocage T°38°C sans ensemble.



T1

943801T1

94C302571

943801S-3520T1+3726+2471C

Mitigeur thermostatique bain-Douche Poignées laiton. Blocage T°38°C avec ensemble T1. Douchette 1 jet.



T3

943801T3

94C302572

943801S-5840T3+3726+2471C

Mitigeur thermostatique bain-Douche Poignées laiton. Blocage T°38°C avec ensemble T3. Douchette 3 jets.



BT

943801BTNM

94C307785

Mitigeur thermostatique bain-Douche Poignées laiton. Blocage T°38°C avec ensemble BT. Douchette 3 jets.

Cartouche: 1701T + 4000

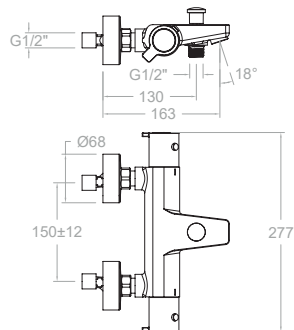

943601S

94C306437

Mitigeur thermostatique bain-Douche Poignées laiton. Blocage T°38°C.



E3/1C2A1U3

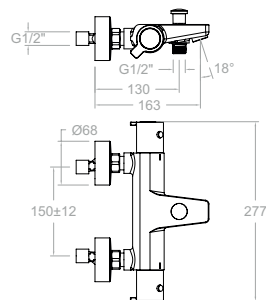

943602S

94C306598

Mitigeur thermostatique bain-Douche Poignées laiton. Blocage T°38°C.



E3/1C3A1U3

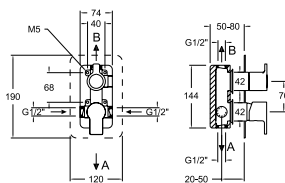
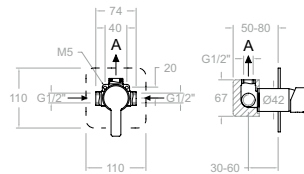
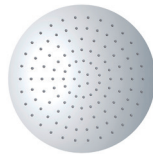
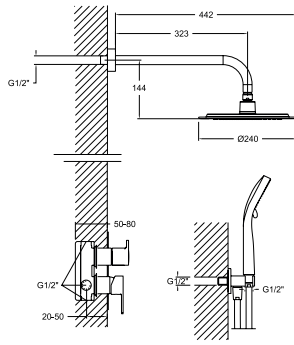

941502RP240

94C301586
941502S+B350+RP240+3796+2876BT+2471C

941502RP240NM

94D303675
941502SNM+B350NM+RP240NM+3796NM+2876BTNM+2475CNM

Ensemble encastré mitigeur douche 2 voies avec douche de tête ABS anticalcaire Ø240 mm et douchette ABS 3 jet, coude support sortie d'eau et flexible. Corp encastré inclus.

941502RM250

94D302556
941502S+B350+RM250+3796+2876BT+2471C

Ensemble encastré mitigeur douche 2 voies avec douche de tête métallique anticalcaire Ø250 mm et douchette ABS 3 jet, coude support sortie d'eau et flexible. Corp encastré inclus.

941801S

94D301584
XX1801-KX1+940001N-35

Mitigeur encastré 1 voie. Corp encastré inclus.

941502S

94C301585
XX1502-KX2+945100+940001N-35

941502SNM

94C303682
XX1502NM+KX2NM+945100NM+940001N-35NM

Mitigeur encastré 2 voies. Corp encastré inclus.

BX941502RP240

94G301706

BX941502RP240NM

94G303677

BX941502RM250

94G302557

BOX PALET, 6 unités.



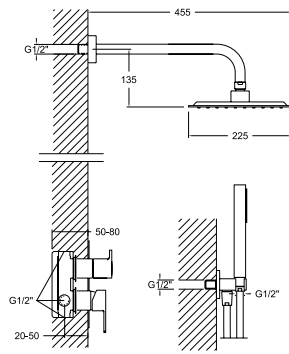

941502RPK225

94C301587

941502KS+B350+RPK225+4796+4713P+2471C

Ensemble encastré mitigeur douche 2 voies avec douche de tête ABS anticalcaire 225*225 mm et douchette ABS 3 jet, coude support sortie d'eau et flexible. Corp encastré inclus.

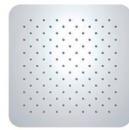

941502RK250

94D302558

941502KS+B350+RK250+4796+4713P+2471C

Ensemble encastré mitigeur douche 2 voies avec douche de tête 250*250 mm et douchette ABS 3 jet, coude support sortie d'eau et flexible. Corp encastré inclus.

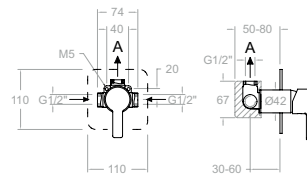

941801KS

94D301699

XX1801+K1+940001N-35

Mitigeur encastré 1 voie. Corp encastré inclus.

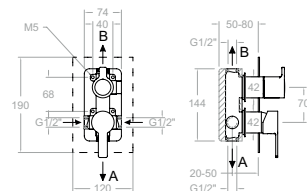

941502KS

94C301700

XX1502+K2+945100+940001N-35

Mitigeur encastré 2 voies. Corp encastré inclus.

BX941502RPK225

94G301707

BX941502RK250

94G302559

BOX PALET, 6 unités

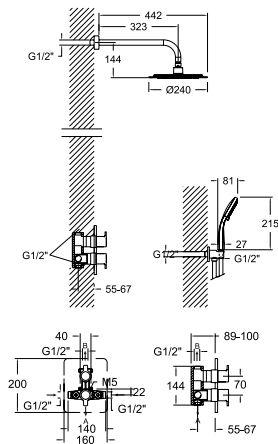

948712RP240

94D302547
948712S+BHRP240+2876BT+3796+2471C

948712RP240NM

94D303671
948712SNM+BHRP240NM+2876BTNM+3796NM+2475CNM

Ensemble encastré thermostatique douche 2 voies avec douche de tête ABS anticalcaire Ø240 mm et douchette ABS 3 jet, coude support sortie d'eau et flexible. Corp encastré inclus.



948712RM250

94D302551
948712S+BHRM250+2876BT+3796+2471C

Ensemble encastré thermostatique douche 2 voies avec douche de tête métallique 250 mm et douchette ABS 3 jet, coude support sortie d'eau et flexible. Corp encastré inclus.

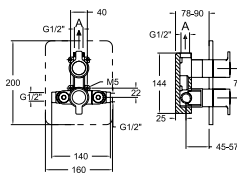

942411S

94D302545
XX2411-KTX1+945000+945100

Thermostatique douche à encastrer, 1 voie. Poignées laiton. Blocage T° 38°C. Corp encastré inclus.

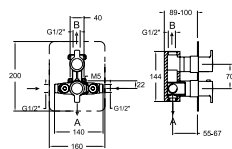

948712S

94D302546
XX8712-KTX2+945000+945100

948712SNM

94D303683
XX8712NM+KTX2NM+945000NM+945100NM

Thermostatique douche à encastrer, 2 voies. Poignées laiton. Blocage T° 38°C. Corp encastré inclus.



BX948712RP240

94G302548

BX948712RP240NM

94G303672

BX948712RM250

94G302552

BOX PALET, 5 unités

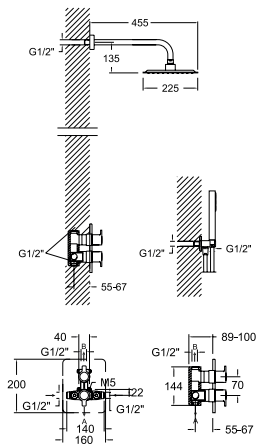

948712RPK225

94D302549

948712KS+BNRPK225+4716PR+4796+2471

Ensemble encastré thermostatique douche 2 voies avec douche de tête ABS anticalcaire 225*225 mm et douchette ABS 3 jet, coude support sortie d'eau et flexible. Corp encastré inclus.

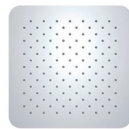

948712RK250

94D302553

948712KS+RK250+B350+4716PR+4796+2471C

Ensemble encastré thermostatique douche 2 voies avec douche de tête ABS anticalcaire 250*250 mm et douchette ABS 3 jet, coude support sortie d'eau et flexible. Corp encastré inclus.

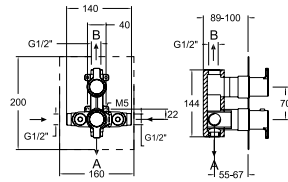

948712KS

94D302915

XX8712+KT2+945000+945100

Thermostatique douche à encastrer, 2 voies. Poignées laiton. Blocage T° 38°C. Corp encastré inclus.



BX948712RPK225

94G302550

BX948712RK250

94G302555

BOX PALET, 6 unités.